

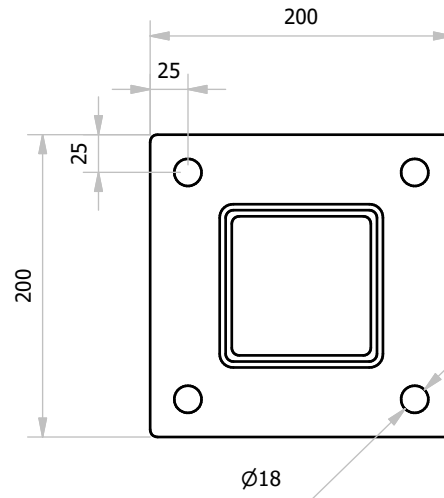

POST with BASE PLATE OPTIONS

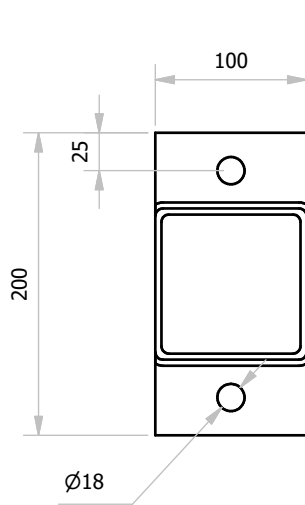

200x100x10 M.S. Plate
with 2xØ18mm Holes



200x200x10 M.S. Plate
with 4xØ18mm Holes

Drawing No.

Uni Pier 2024.005.1.1

Finish:

BATCH HOT DIPPED GALVANISED

SHEET SIZE

A4

UNI-PIER Australia Pty Ltd

ACN 131 900 546
PO BOX 5258 KAHIBAH, NSW 2283
172 Casino Street, SOUTH LISMORE, NSW 2480
Phone: 1300 366 362
www.unipier.com.au

This drawing is the property of Uni Pier Australia Pty Limited and is protected by Copyright and not transferable. It is illegal to copy, communicate and/or disseminate this drawing to a third party without written permission from Uni Pier Australia Pty Limited and any infringement will be prosecuted under Australian & International Law.

UNI-PIER®